

**Corrosion Resistant Series
Noryl Centrifugal Pump
Model Number - C M N B 4 X**
1 2 3 4 5 6 7 8



Shown with Optional Motor.

Specifications

- | | |
|---------------|--|
| 1. Type | <u>C</u> : Centrifugal |
| 2. Mounting | <u>M</u> : Motor Mounted |
| 3. Material | <u>N</u> : Noryl Body, Cover & Impeller |
| 4. Mech. Seal | <u>B</u> : Buna N, SS Case, Carbon Seal, Ceramic Seat
(<u>V</u> : Viton, SS Case, Carbon/Ceramic)
(<u>P</u> : Viton, Polypropylene (PP) Case, Carbon/Ceramic)
(<u>C</u> : Viton, PP Case, Silicon Carbide Seal & Seat)
(<u>N</u> : Neoprene, PP Case, Carbon/Ni-Resist)
(<u>H</u> : High Pressure Buna N, SS Case, Carbon/Ceramic) |
| 5. Size | <u>4</u> : #4 Impeller (90 GPM Max.)
w/ 1-1/2" Inlet and Discharge Ports |
| 6. Motor HP | <u>X</u> : Motor Not Included
(<u>1</u> : 1/3 HP) (<u>4</u> : 1 HP) (<u>7</u> : 3 HP)
(<u>2</u> : 1/2 HP) (<u>5</u> : 1-1/2 HP)
(<u>3</u> : 3/4 HP) (<u>6</u> : 2 HP)
{Note: All Optional Motors are 3450 RPM} |
| 7. Motor Type | <u> </u> : N/A
(<u> </u> & Motor Selected: ODP 1 Phase)
(<u>3</u> & Motor Selected: ODP 3 Phase)
(<u>T</u> & Motor Selected: 1 Phase TEFC)
(<u>3T</u> & Motor Selected: 3 Phase TEFC) |
| 8. Impeller | <u> </u> : Closed Type
(<u>O</u> : Open Type) |

Additional Specifications

- Maximum Discharge Head - 90 Ft
- Temperature Range - +0 to +190°F
- Impeller - Noryl
- O-rings - Nitrile
- Shaft - 316 Stainless Steel (Supplied with Motor)



Dimensions

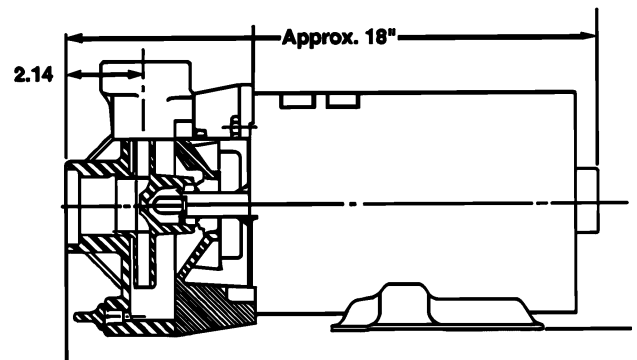
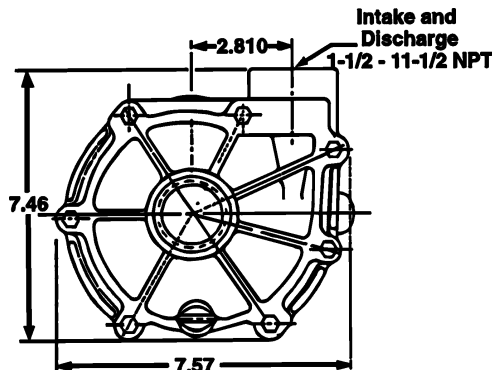

Corrosion Resistant Series Noryl Centrifugal Pump Model Number – CMNB4X

Performance

CRP Closed Impeller #4
(Based on Water @ Ambient Temp.)

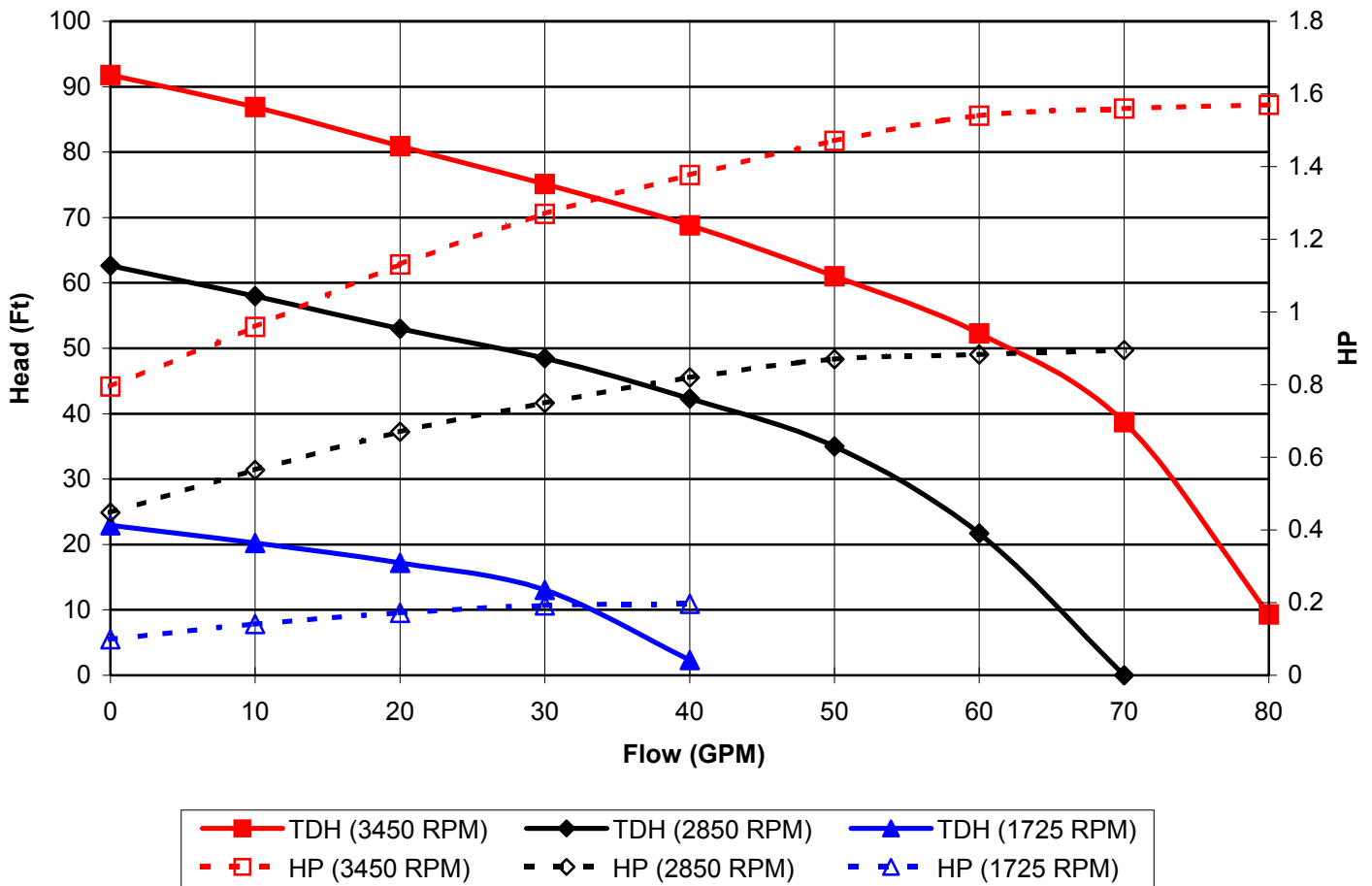

INDUSTRIAL PRODUCTS GROUP
375 Fifth Avenue NW • New Brighton, MN 55112-3288
Phone: (651) 766-6300 • 800-471-0460 • Fax: 800-672-7023
www.hypropumps.com www.shertech.com